

Stack Dimensions

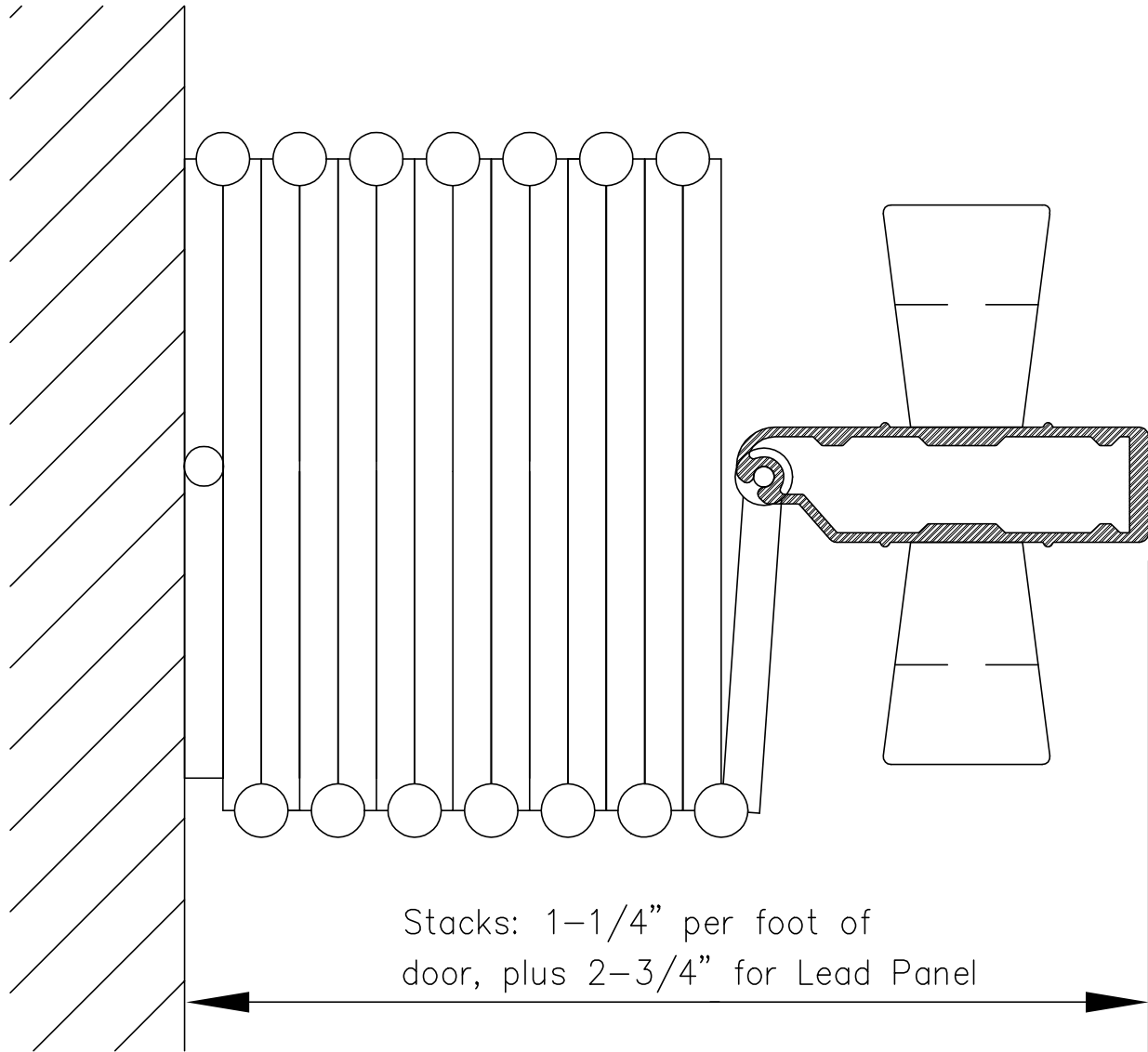

CAD STD M-440

○ STACK DIMENSIONS — MODEL 440