

# Installation Instructions: \_\_\_\_\_

**Type of Operation: Crank**

**Type of Mount: Between Wall Without Lintel**

All directions are provided assuming the installer is looking at the door from the coil side of the opening. (see drawing below) Some of the pictures are taken in the plant using our adjustable opening where we install and test every door before it is sent to you.

Proper installation of our doors can only be done if you are in a good mood. To that end, we have put a couple See's Suckers in the goody bag for your enjoyment.

If you have questions about the installation, feel free to call us at 503.357.7181 from 7am until 5pm Monday through Thursday, Fridays 7am until 3pm (Pacific time).

Now let's get started.

## View From Coil Side

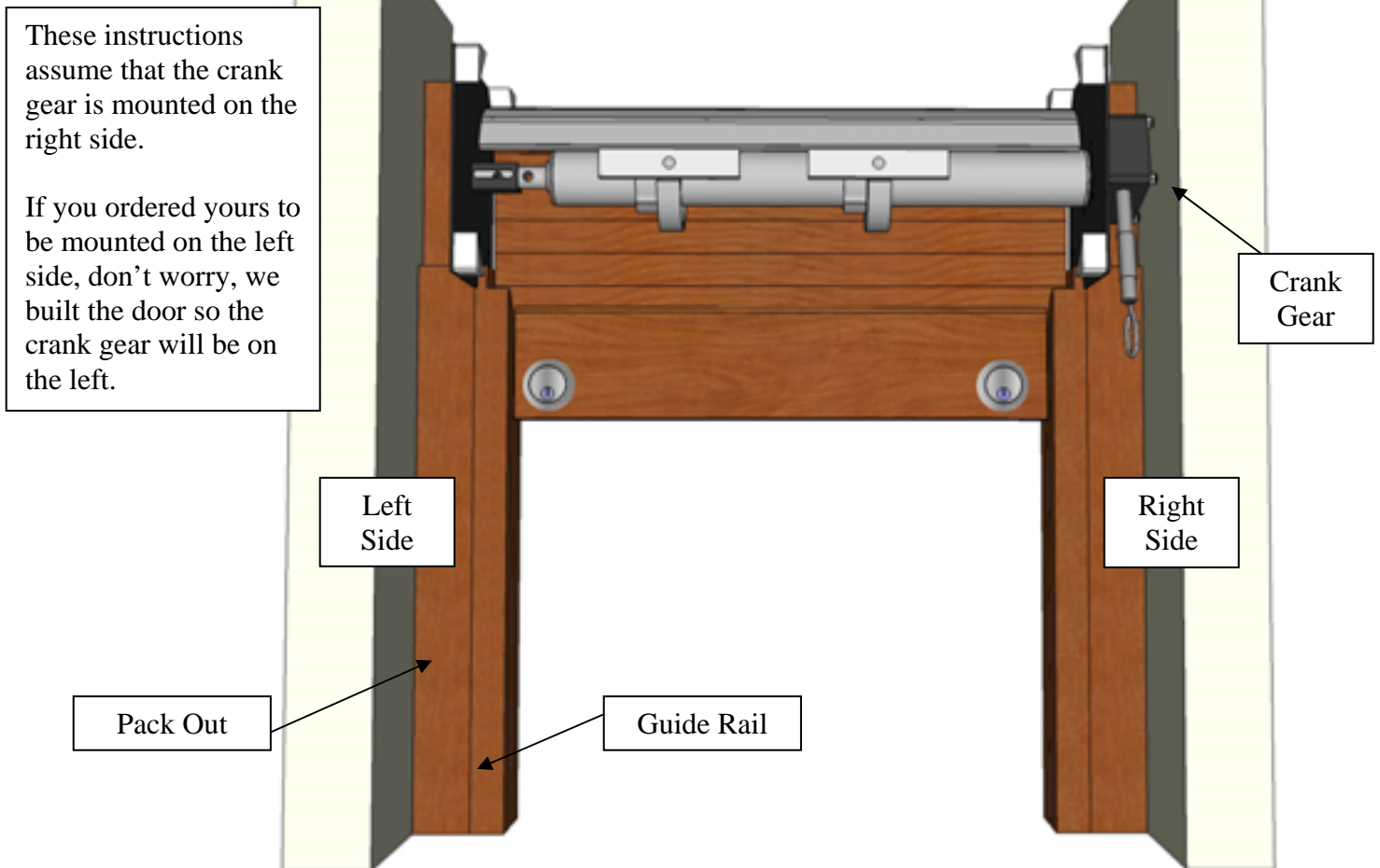

## Step 1

Lay out all the parts on a clean smooth surface.

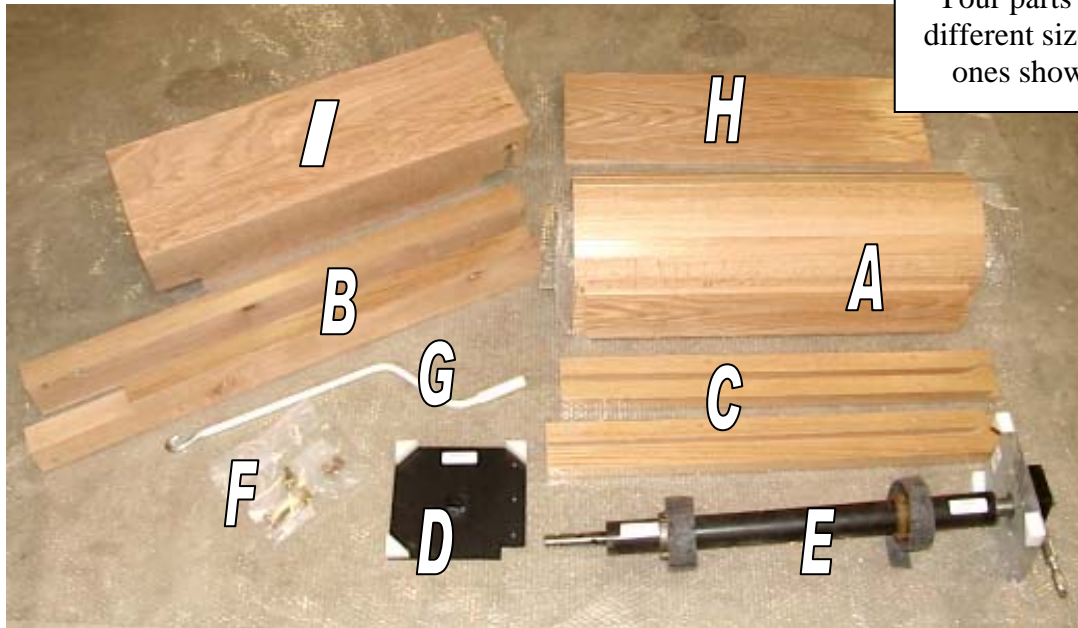

Your parts will be a different size than the ones shown here.

## Items Included In Crate

- |   |             |   |                           |   |                     |
|---|-------------|---|---------------------------|---|---------------------|
| A | Curtain     | D | End Plate                 | G | Crank Handle        |
| B | Pack Outs   | E | Barrel, Crank & End Plate | H | Fascia (if ordered) |
| C | Guide Rails | F | Goody Bag (see below)     | I | Hood (if ordered)   |

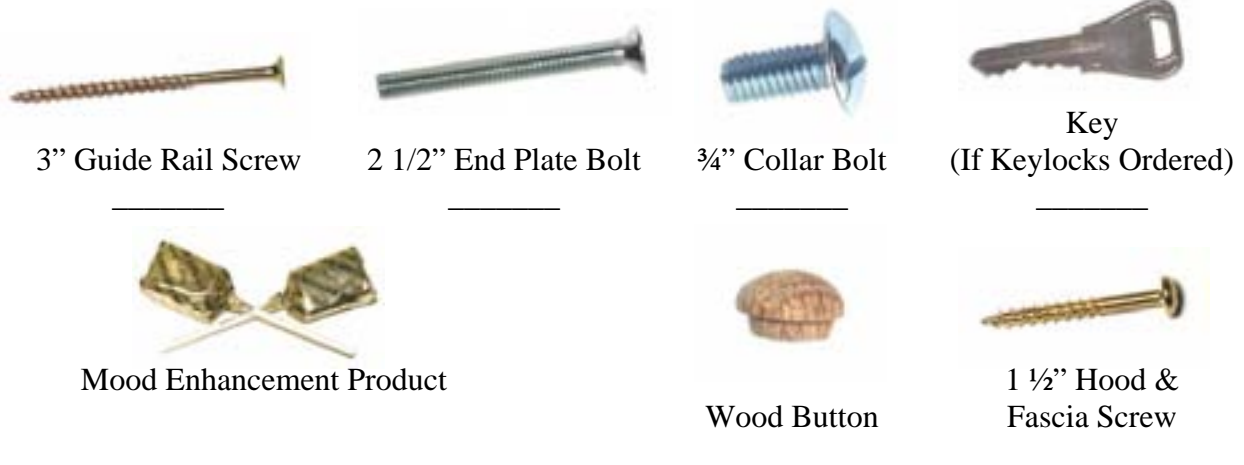

The 2" Shaft Bolt, Capture Nut & Washers (shown at left) are shipped installed as shown to the right. The bolt must be removed prior to installation. Set it somewhere that you can find it because you will need it later.



## Step 2

Your roll-up door has been built based on the measurements in the drawing below.

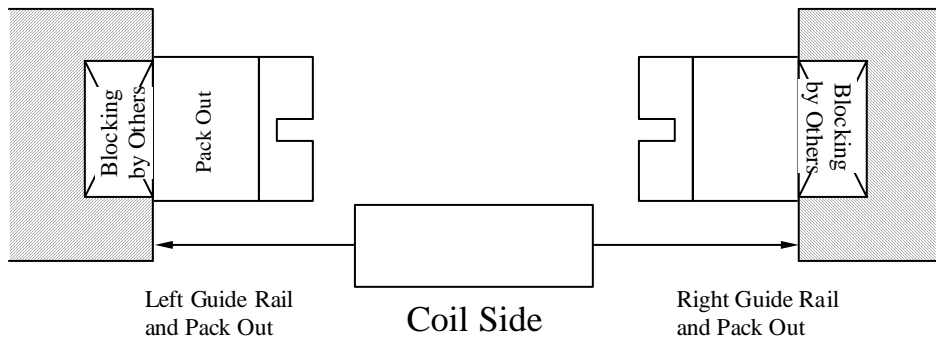

The left and right pack outs have been labeled. Position the left pack out (making sure it is plumb) and secure it using the 3" screws provided. Attach the right pack out making sure it is plumb and level in height with the left pack out. Next, mount the left guide rail on top of the left pack out using the 3" screws provided. The right guide rail can be attached in a similar fashion.



### Viewed From Coil Side

Left

Right

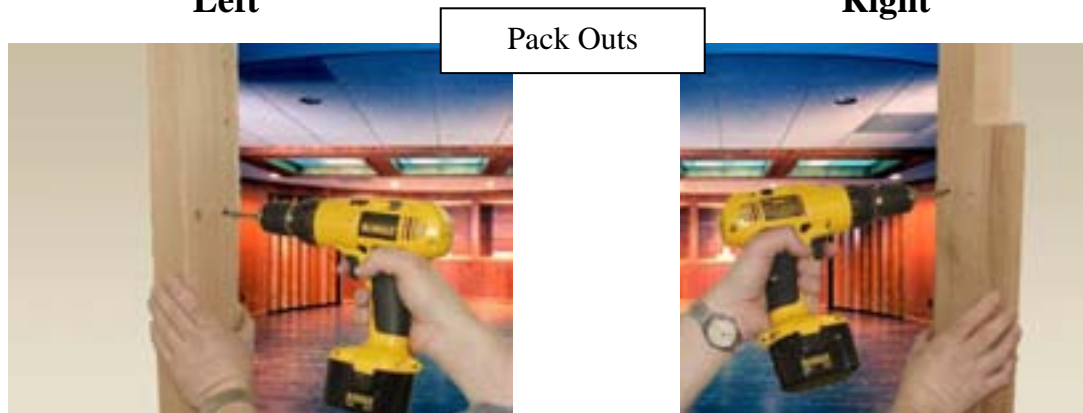

Guide Rails mounted on top of Pack Outs



### Step 3

Standing on the coil side of the door slowly uncoil the curtain while feeding it into the installed guide rails. This curtain weighs \_\_\_\_\_ pounds. If you are by yourself this would be a good time to start making friends. We suggest using at least \_\_\_\_\_ people for this step. **After the door has been completely uncoiled into the guide rails be very careful to not let the top of the door flop over. It can break the top curtain slat.**



**The Roll-Up Guys  
Working on a small one**



**Roll-Up Guys & Friends  
Uncoiling a Big One**

A pencil can be used to hold the metal slats up.



Putting a couple wood blocks on the sill gives you a way to get your fingers out.



## Step 4

Install the loose end plate (the side will be marked with a sticker) onto the pack out using the 2 ½” bolts provided. The notch on the end plate will fit over the top of the guide rail.



NOTE: You will need to work at the top of the Roll-up door for the *entire width* of the unit. Be sure to allow access to the entire top after installation is complete.

## Step 5

The crank mechanism, barrel and end plate have been assembled at the factory. Your mission is to set the shaft sticking out of the end of the barrel onto the U channel of the installed plate then bolt the other end plate onto the pack out using the 2 ½” bolts provided.

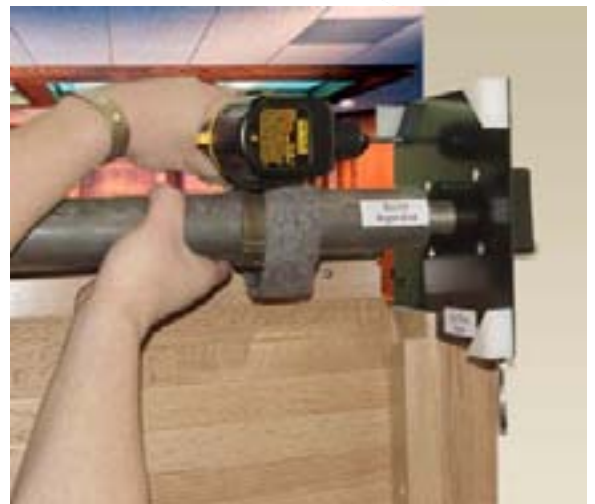
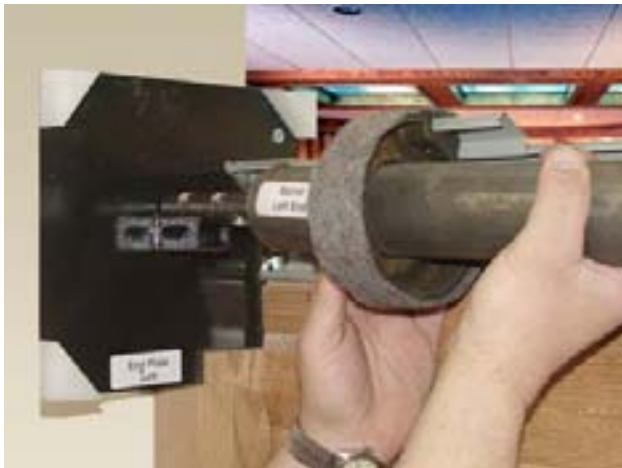

## Step 6

Place the short metal curtain slats in the collar notches and attach them using the 3/4" machine screws provided.



## Step 7

The secret to a smooth operating door is tensioning the internal spring hidden inside the barrel. This is accomplished by using two metal rods or large screwdrivers. Insert a rod into a shaft-tensioning hole and pull down ¼ turn. Holding this position set the second rod into the next tensioning hole. While pulling down with the second rod, release the first and continue “walking” the rods in this manner.

This door was installed at the factory and tested before being packaged. We found that it worked well with \_\_\_\_\_ quarter turns of tension. (same as \_\_\_\_\_ full turns) Secure the shaft in place using the 2" bolt, flat washers and capture nut provided.



**Before going any further – double check that the shaft bolt has been secured in place with the flat washer and capture nut.**

**It would also be wise to operate the door 10 to 15 times and then double check that all the bolts and screws are still tight.**

## Step 8

If you ordered a hood it can be installed by sliding it over the end plates. Use the 1 ½” brass plated screws provided to secure the hood to the corner blocks. Two holes have been predrilled on the bottom of the hood for your convenience.



If a fascia was ordered it can be installed using the 1 ½” brass plated screws provided. The Fascia has been predrilled for your convenience.



## Step 9

Concealing the guide rail screws with the wood buttons provides the final touch. If you are concerned about them working out, a dab of glue will prevent that from happening.



## Step 10

At this point you only have one thing left to do. Find those suckers before someone else does.

*Thanks for taking the time and care to install our door in a way that really shows off the quality that we put into each and every one of them.*





# Check List

Customer Name: \_\_\_\_\_

Order Number: \_\_\_\_\_

Ship Date: \_\_\_\_\_

- \_\_\_\_\_ Curtain
- \_\_\_\_\_ Pack Outs
- \_\_\_\_\_ Guide Rails
- \_\_\_\_\_ End Plate
- \_\_\_\_\_ Barrel, Crank, End Plate Assembly
- \_\_\_\_\_ Crank Handle
- \_\_\_\_\_ Fascia
- \_\_\_\_\_ Hood
- \_\_\_\_\_ Curtain Stop & Instructions
  - \_\_\_\_\_ Standard Plastic
  - \_\_\_\_\_ Special Wood
  
- \_\_\_\_\_ Hardware Bag
  - \_\_\_\_\_ Guide Rail Screws
  - \_\_\_\_\_ Collar Bolts
  - \_\_\_\_\_ Suckers
  - \_\_\_\_\_ Keys
  - \_\_\_\_\_ Pack Out Screws
  - \_\_\_\_\_ 2 1/2" End Plate Bolts
  - \_\_\_\_\_ Buttons
  - \_\_\_\_\_ Hood & Fascia Screws
  - \_\_\_\_\_ Thank You Note
  
- \_\_\_\_\_ Shaft Bolt, Capture Nut & Washers
- \_\_\_\_\_ Shop Drawings
- \_\_\_\_\_ Installation Instructions
  - \_\_\_\_\_ Distance between back of guide rails
  - \_\_\_\_\_ Curtain weight
  - \_\_\_\_\_ Number of people to install curtain
  - \_\_\_\_\_ Number of quarter turns
  - \_\_\_\_\_ Page 1 note about left mounted crank
  
- \_\_\_\_\_ End Plate Stickers have been attached
- \_\_\_\_\_ Guide Rail Stickers have been attached
- \_\_\_\_\_ Barrel Stickers have been attached
- \_\_\_\_\_ Pack Out Stickers have been attached