

Lead Post, Jamb Moulding & Handle

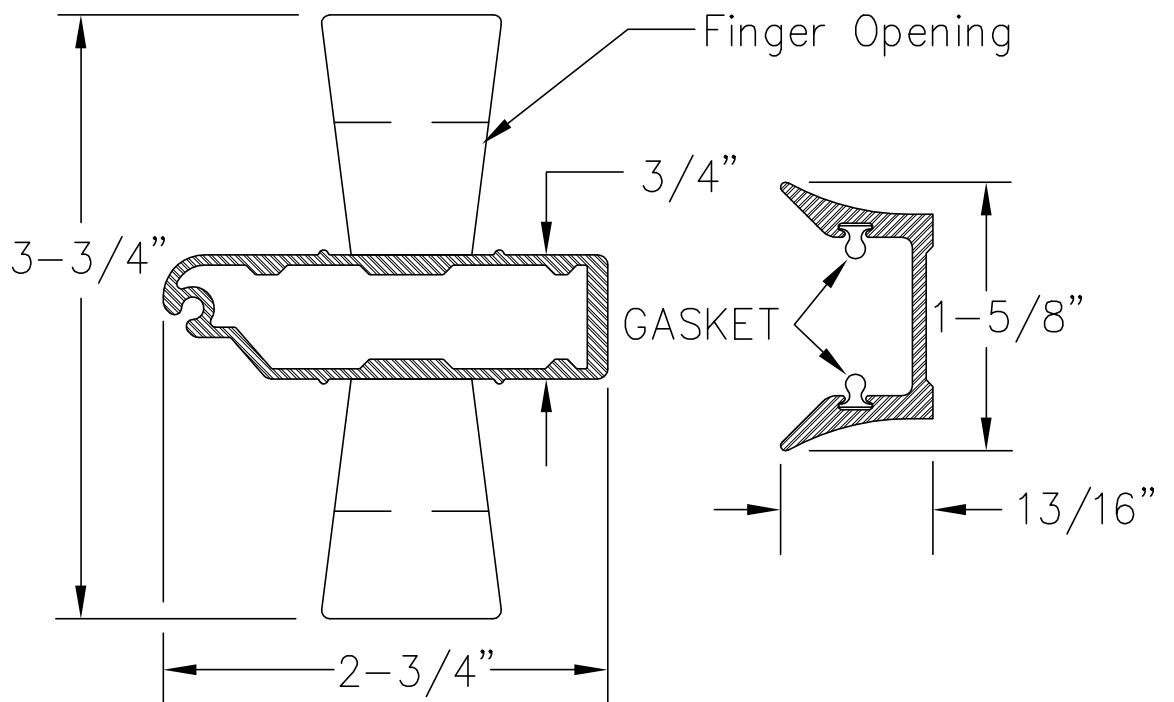

CAD LPJM-740

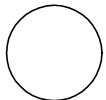

LEAD POST JAMB MOLDING & HANDLE — MODEL 740