

Mounting Panel

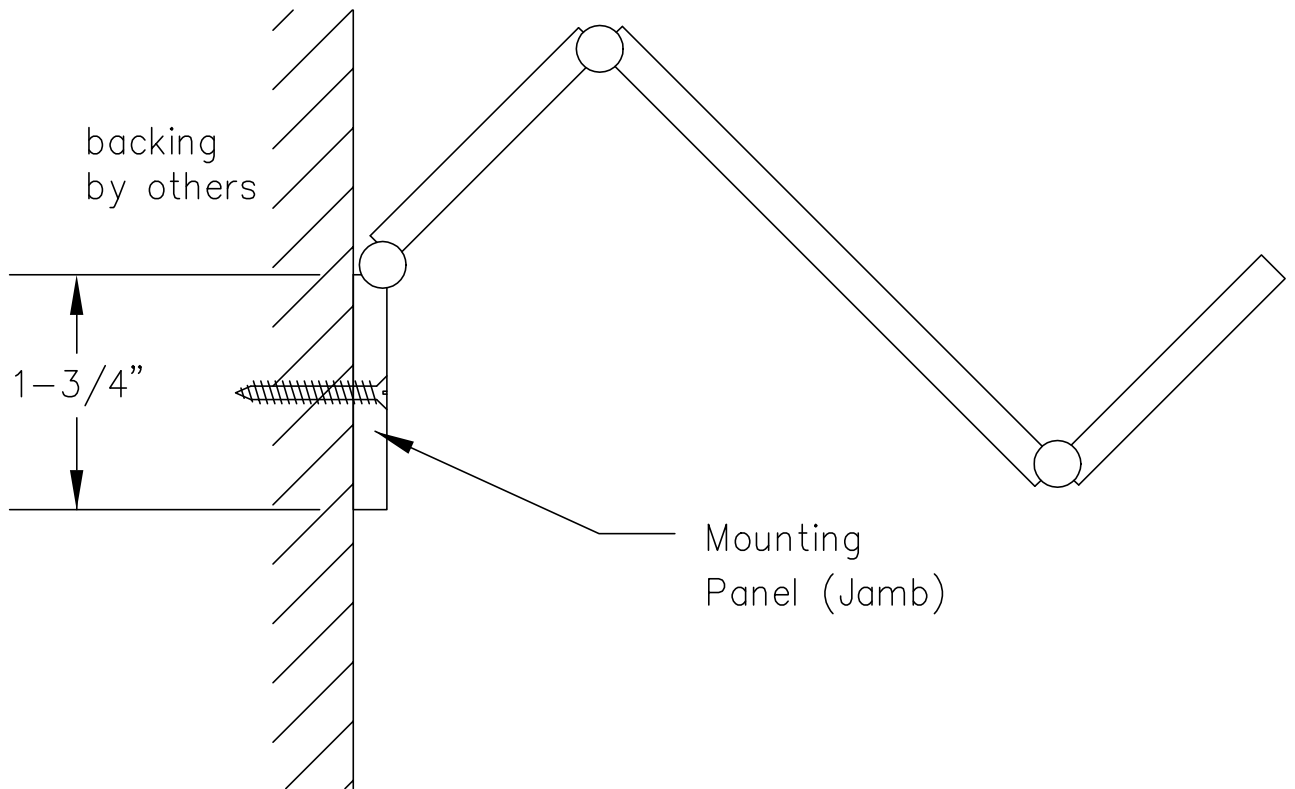

*Direction of mounting panel (jamb)
varies based on door construction.
Consult factory for specific information.*

CAD MPAN-640

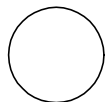

MOUNTING PANEL — MODEL 640