

# Stack Dimensions

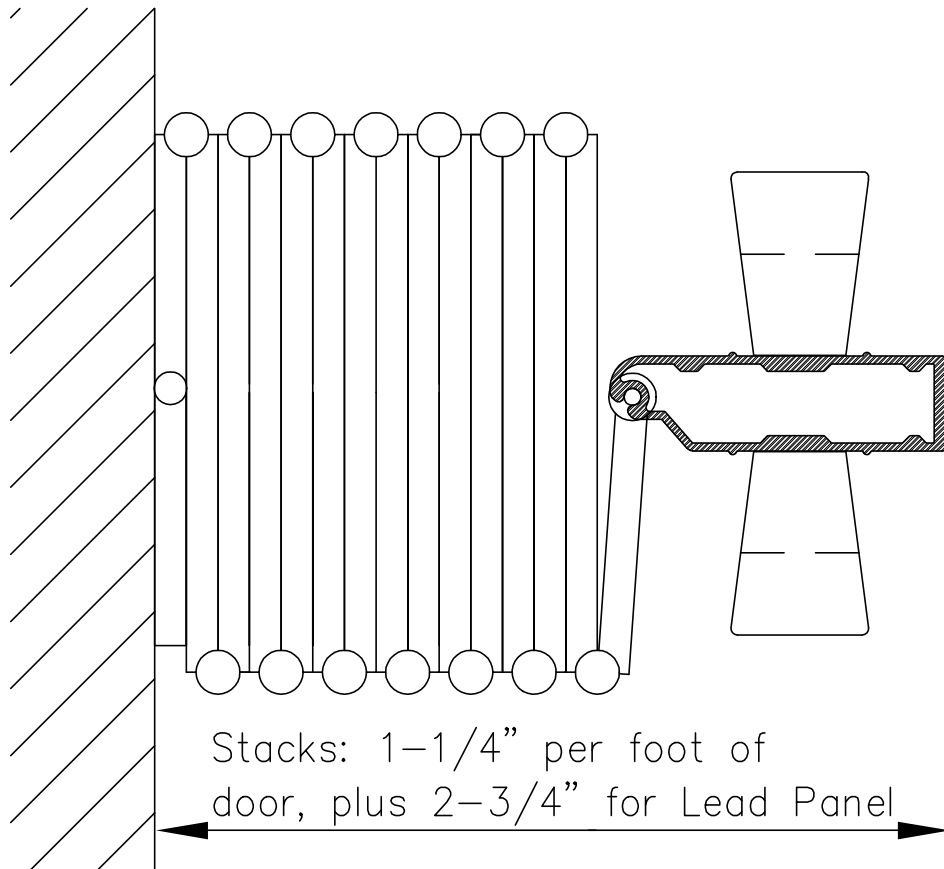

CAD STD M-240

○ STACK DIMENSIONS — MODEL 240