

Intermediate Rolling Post

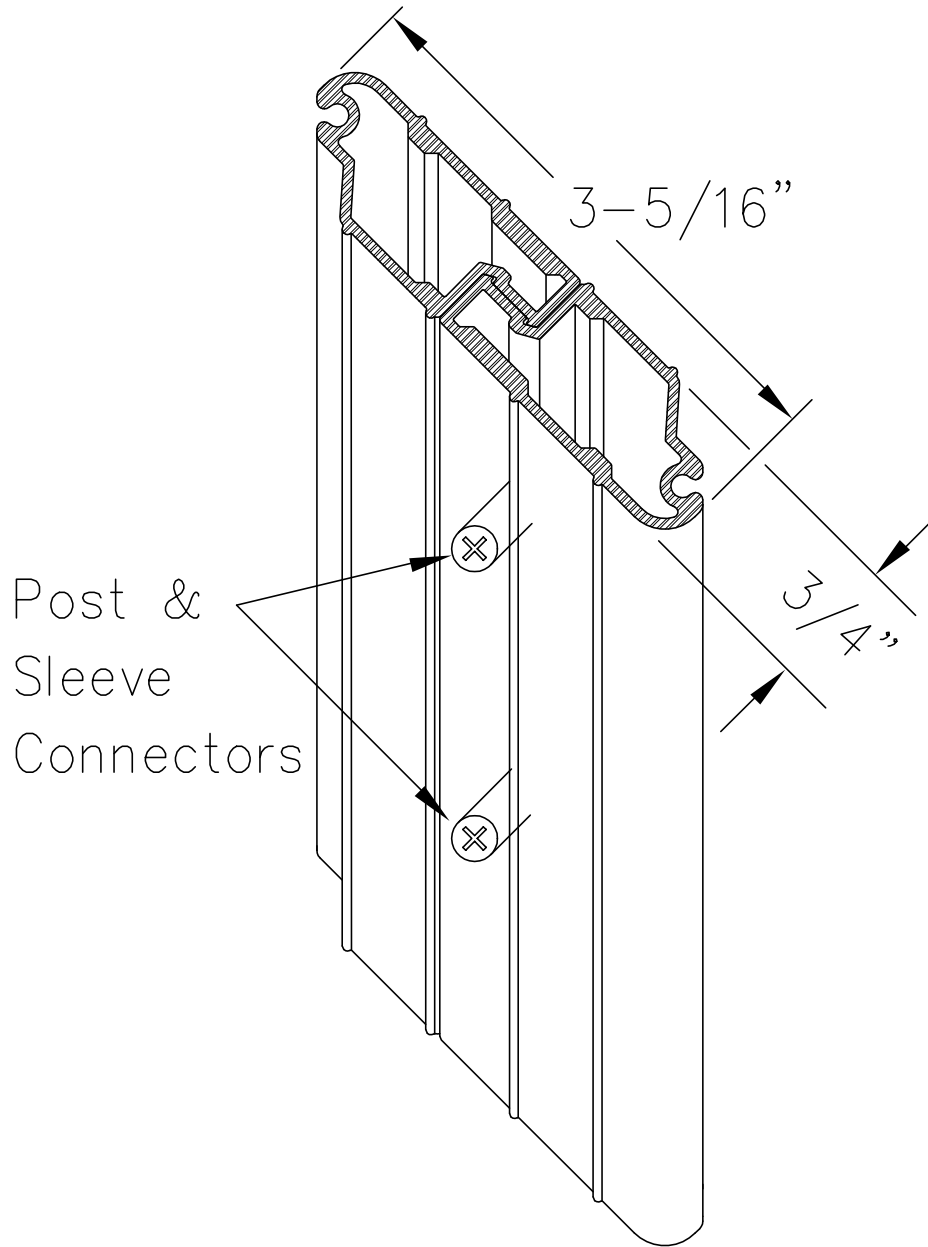

CAD IRP-240

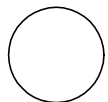

INTERMEDIATE ROLLING POST – MODEL 240