

Lead Post, Jamb Moulding & Handle

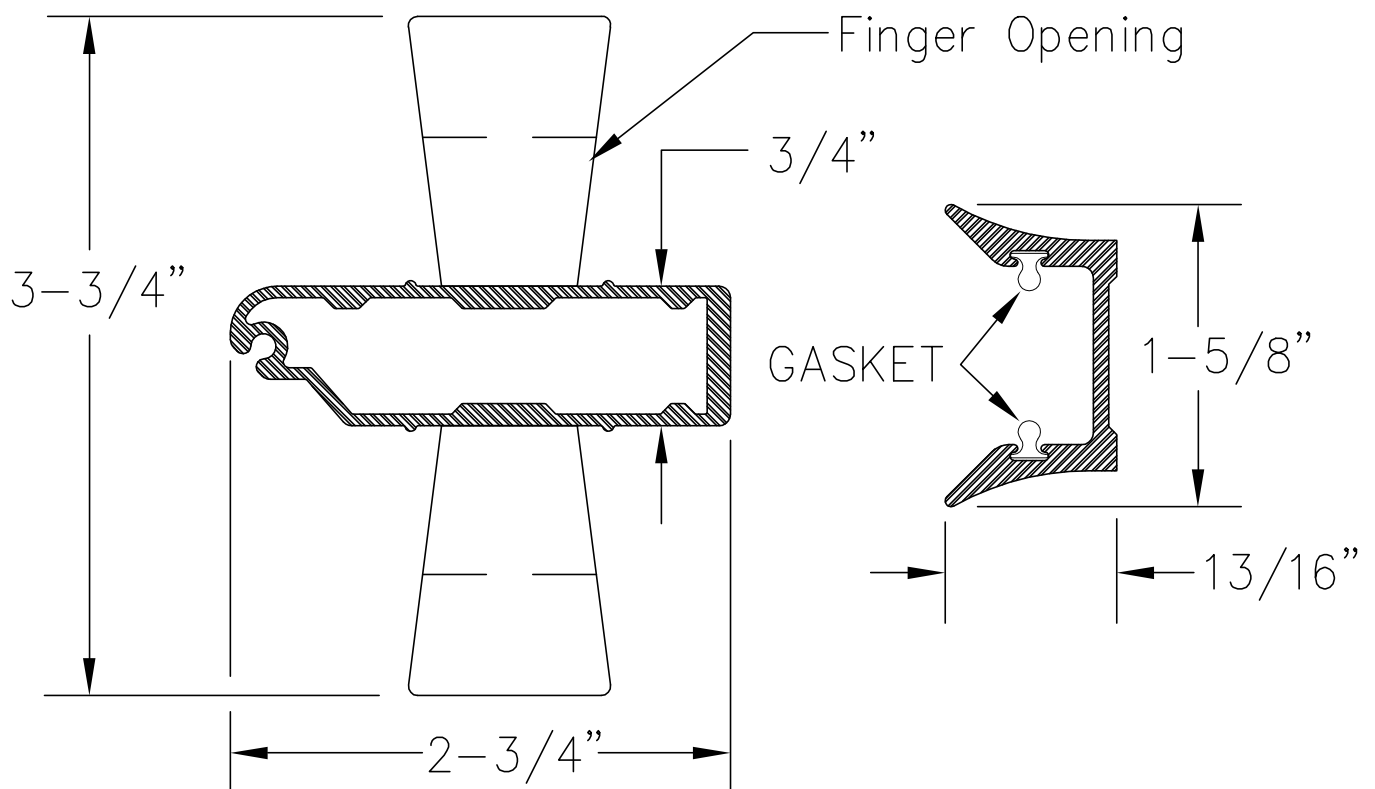

CAD LPJM2100

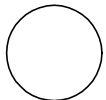

LEAD POST, JAMB MOULDING & HANDLE – MODEL 2100